



# LEODIS STAIRLIFTS

HELPING YOU WITH THE UPS AND DOWNS IN LIFE

Est. 1991



# Are you having problems or struggling to get up and down your stairs?

Loss of mobility throughout the home can be a frustrating and disheartening experience. The decision of whether to stay in your home or move house is a very difficult choice. Having a stairlift fitted could be the ultimate solution to a difficult problem, allowing you to stay within the safety and security of your own home.

## **About Leodis Stairlifts**

Established since 1991, we have helped people regain their independence in their own home, offering them free, impartial advice and a personal service, as expected of a family run company, that is second to none.

At Leodis Stairlifts our aim is to make buying a curved stairlift a smooth and easy process for you. Our service and support is designed to provide you with confidence and complete peace of mind.

## **Buying a curved stairlift from Leodis Stairlifts**

Quality, reliability and safety are foremost when buying a stairlift and we only supply the best. As independent supplier's of the leading manufacturers we can offer impartial stairlift advice and recommend the stairlift that suits your needs both now and in the future.

As there are many curved staircase configurations we understand the confusion that buying a stairlift can bring. In this brochure we hope to answer any questions you may have and help guide you effortlessly through the process of buying a stairlift. From your free, no obligation, home survey through to installation of your curved stairlift, we're there every step of the way.

Our curved stairlifts are available both new and reconditioned and can often be installed the very next day following your free home survey.

# Introducing the Leodis Curved Stairlift Range



The Bison 180 curved stairlift is the stylish, unobtrusive solution for your curved staircase.

Offering the quality and reliability expected of a leading stairlift manufacturer coupled with style and elegance that would suit any home.

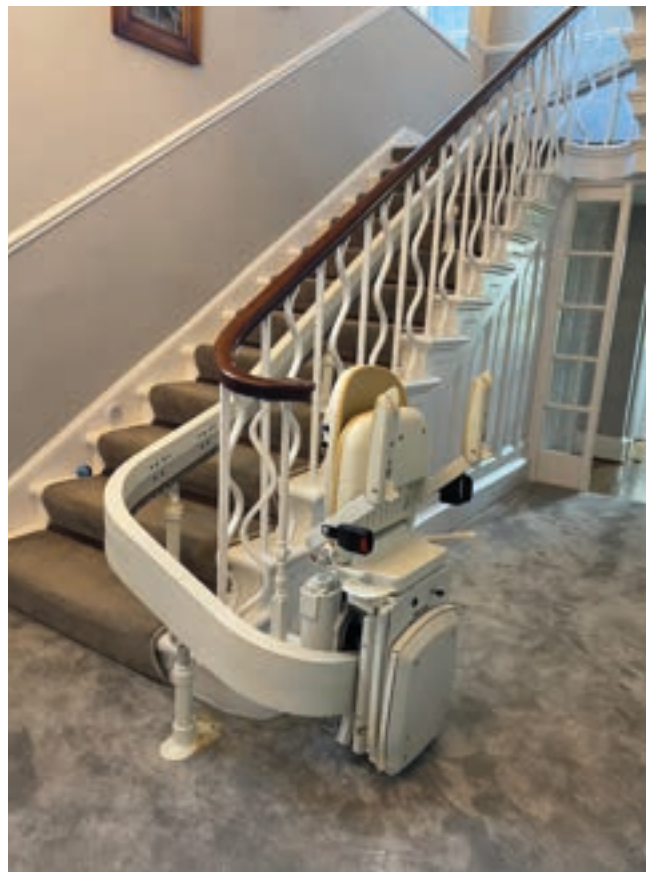

## **Innovative Modular Track**

The concept of the modular track allows the rail to be assembled on site giving faster delivery, often within 24 hours and sometimes even the same day.

Battery charge points are situated at both ends of the track and for your convenience 2 remotes are supplied as standard.



# Staircase Configurations

Each home is different and the beauty of the Bison 180 modular rail is that it will quite easily adapt to your staircase configuration.

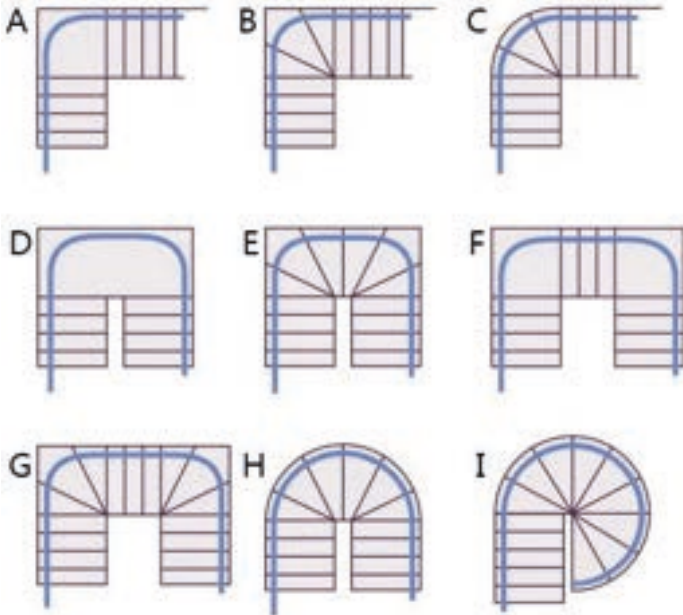

Each track is built directly on site and pieces together to hug the contours of your staircase. A curved stairlift installation takes approx. 3-4 hours.

To make your life even easier we can install tracks with top and bottom wraps / run ons, taking you precisely to where you need to be.



Our curved stairlifts are available to buy new or reconditioned, we even supply this stairlift as a rental.

# Staircase Configurations



The neat and clean looking track fits securely to the staircase. Each track is built to fit each individual staircase.

The Bison 180 folds away neatly allowing plenty of safe access to the stairs for others.

## **The Bison 180 seat**

The comfortable, easy-to-clean seat is fitted with an inertia seat belt and has an easy to use directional lever. Swivelling effortlessly, the seat allows the user safe exit and entry.

Should you require a little more help you might be interested in our powered options. Read on for more information

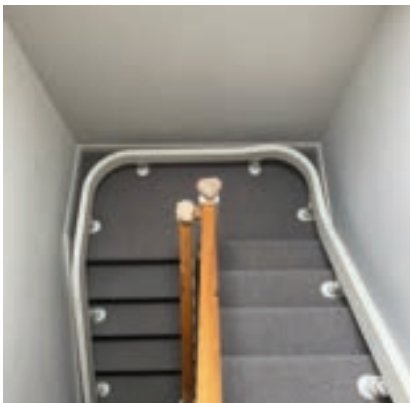

# Personalise Your Stairlift

Available in a range of 6 colours, the Bison 180 will complement your home perfectly.



## Optional Extras

For those of you requiring a little more help with manual features such as the swivel seat and footplate, we have powered options available to make your journey on the stairs even easier.

Whilst features such as the swivel seat and footplate are simple to use, for extra comfort and easy of use, powered options are also available.

**Please ask your Leodis Representative for details**

# Hinged Track



Where space is limited, or the stairlift rail would present an obstruction, our hinged rail is the ideal solution.

The lightweight rail automatically folds out of the way leaving your hallway clear while your stairlift is not in use.

The stairlift can be parked in one of its charge points using the remote control provided.

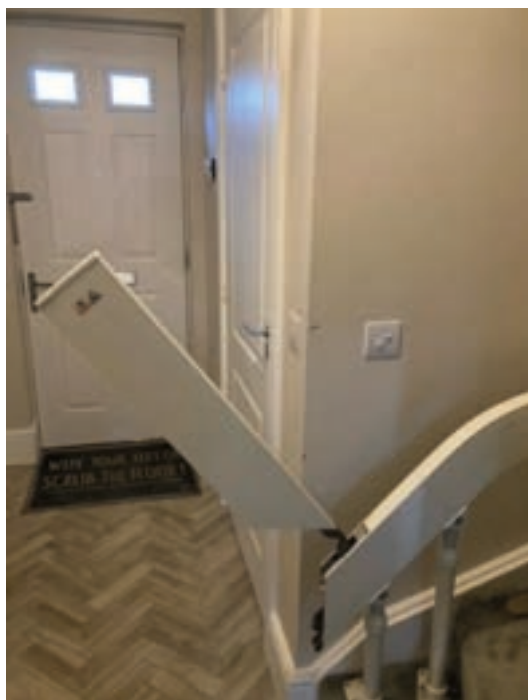

# Features of the Bison 180 Curved Stairlift

As expected with a quality product the Bison 180 has many features fitted as standard to aid your comfort and use.

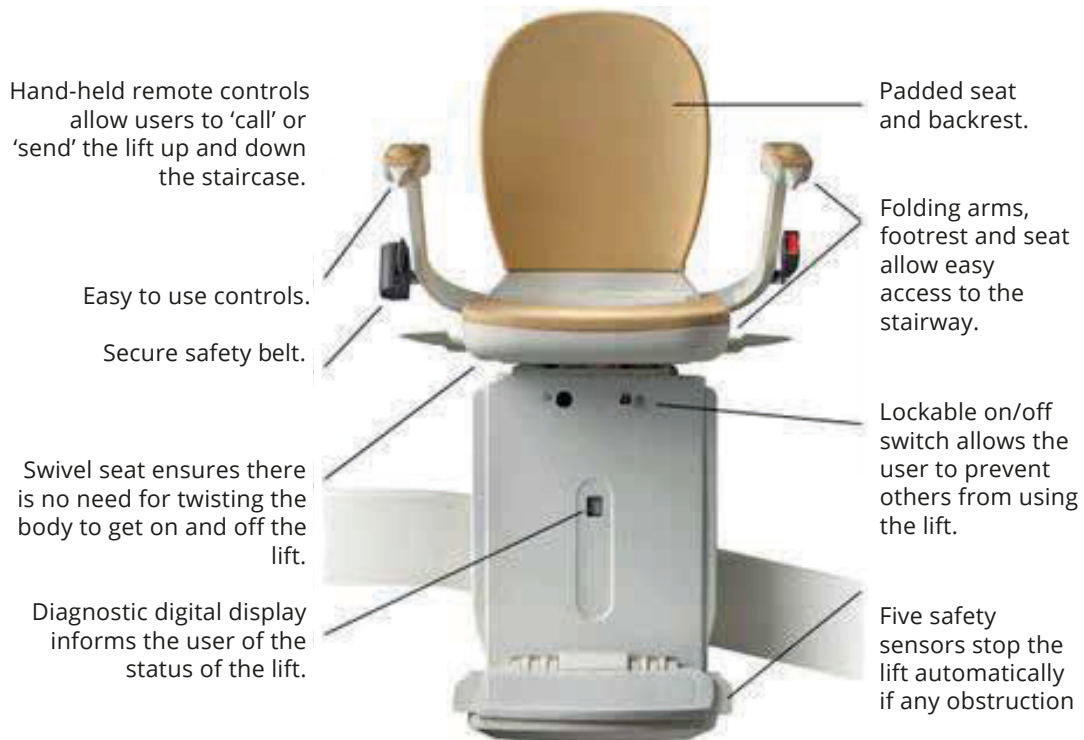

## Easy to use swivel seat fitted as standard

The paddle lever allows you to effortlessly swivel the seat for safe exit and entry onto the stairlift, however for your convenience you may wish to opt for a powered swivel(Please ask for more details).



## Easy release seat belt

For your safety and comfort all our curved stairlifts are fitted with inertia seat belts.



## Finger light control

Fitted with an easy-to-use Rocker Switch on both arms, the stairlift can be operated with ease, even for those with limited dexterity.





# Safety Features as standard

Your safety is of the utmost importance to Leodis Stairlifts. The curved stairlifts that we supply and install have standard safety features, as expected of the leading manufacturers.



## Safety Sensors

Should your stairlift encounter an obstruction on the staircase the safety sensors on the footplate will immediately halt your stairlift. To release, operate the stairlift in the opposite direction and remove the object before continuing on your journey.

## Diagnostic Display

The Bison 180 stairlift is fitted with a lockable isolation key to prevent unauthorised use of your stairlift and an on/off switch.

A clear diagnostic display allows you to monitor the status of your stairlift and aids any fault-finding. This can often lead to problems being resolved with a quick telephone call rather than the need for a call out.



# Curved Rental Option

If you only need a stairlift for a short time, following an injury, operation or if you have a relative coming to stay, our rental stairlifts offer the perfect solution.

## **This includes:**

- Installation
- First 2 months rental - then £50 per month thereafter payable by standing order
- 24 hour response cover (telephones are manned 24 hours a day
- by qualified engineers)
- Removal when no longer required
- No minimum or maximum rental period
- All parts and labour covered throughout the rental period

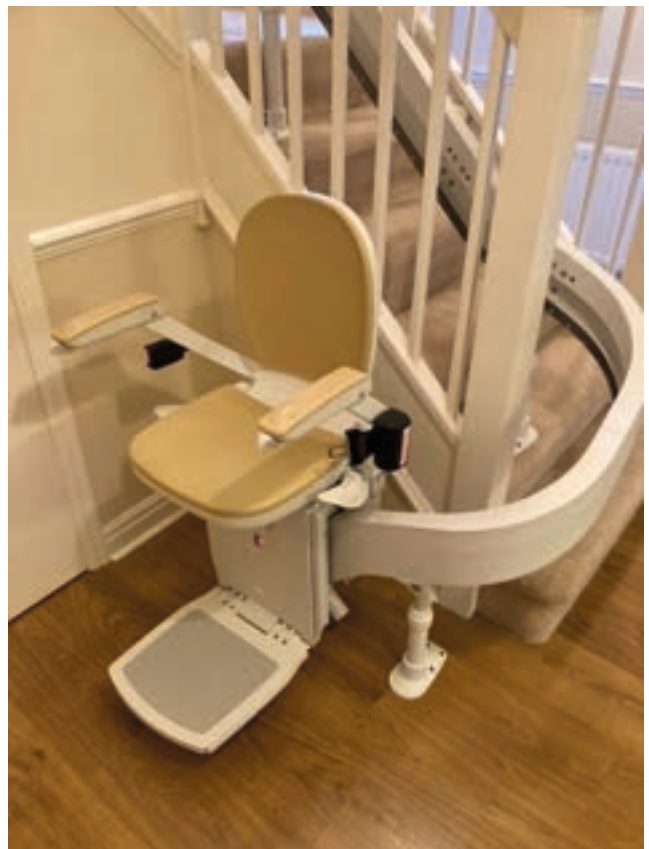

# Handicare Freecurve

The Freecurve stairlift is a bespoke solution for your staircase and can be customised to suit your individual needs.

The unique, single rail design is not only slim and unobtrusive on your stairs, it also enables you to choose from a selection of colours to match your home and décor.



The Freecurve also has powered and automatic options to suit your exact needs. The almost limitless customisable options for the Freecurve make it the perfect stairlift for any home.

The load capacity on the Freecurve is 125 kg (19 ½ st).

# Customise your Freecurve

The Handicare Freecurve seat comes in a wide variety of styles and choices as well. You can choose from Classic, Elegance or Alliance seats to further customise your lift. And you can even pick from 3 rail colours.

## Classic seat

The Classic seat is a durable solution which comes in a choice of three colours. With its leather look easy to clean seats each offering a retractable seat belt as standard.



## Elegance Seat

The Elegance offers a lightly padded, faux leather seat that delivers both comfort and style with the benefit of being durable and easy to clean.



## Alliance Seat

The Alliance's 'retro' style brings a classic yet contemporary feel to your stairlift. Its combination of real wood a choice of three leather look cushioned upholstery options can be chosen to complement your décor.

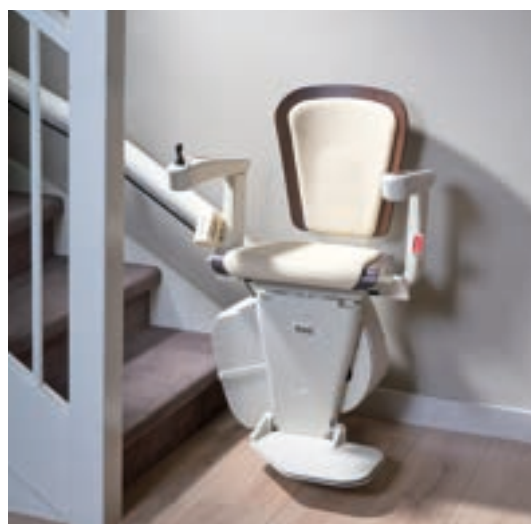

# Handicare 2000

The Handicare 2000 uses a twin tube construction which delivers strength and stability whilst enabling tight bends, in fact this system offers the tightest bend that is available from any stairlift manufacturer making it an ideal choice for compact stairs and hallways.

The weight limit on the 2000 is 115 kg (18 st) and can be increased to 137 kg (21 ½ st) with the heavy duty kit.



This double rail system, designed for a stable and smooth ride, is supplied in light grey, brown or gun metal as standard and is delivered in industry leading manufacturing times.

# Handicare 4000

The Handicare 4000 uses a twin rail which delivers strength and stability whilst enabling tight bends, in fact this system offers the tightest bend that is available from any stairlift manufacturer making it an ideal choice for compact stairs and hallways.

The weight limit on the 4000 is 136 kg (21 st) and can be increased to 160 kg (25 st) with the heavy duty kit.



The Handicare 4000 is compatible with the Handicare Style, Smart, Simplicity and Perch seats.



# Leodis Stairlifts Warranties

Our new and reconditioned curved stairlifts come with:

**2 year parts and labour warranty**

**with 2 service visits included**

**Genuine 24 hour call out service**

After the standard warranty period, we will still be available for services and callouts to your stairlift at our standard rates.

We also offer an extended warranty for a small monthly fee.

Please ask for details.



# Service and Support

**At Leodis Stairlifts we aim to provide a first class service and support that is second to none, giving you and your loved ones complete peace of mind.**

We pride ourselves on the quality of our products and on all of our installations and whilst our stairlifts are completely reliable, from time to time, you may need our assistance or to speak to one of our engineers. As a customer of our you are guaranteed:

- We're a local company contactable 24 hours a day should you or your family have any questions or need a call out.
- Every call you make to us is answered in person by an engineer – you are our priority.
- 24 hour response cover for all our customers, 7 days a week (including evenings, weekends & Bank Holidays).
- 2 FREE service visits on all curved stairlifts.

## Bison 180 Dimentions

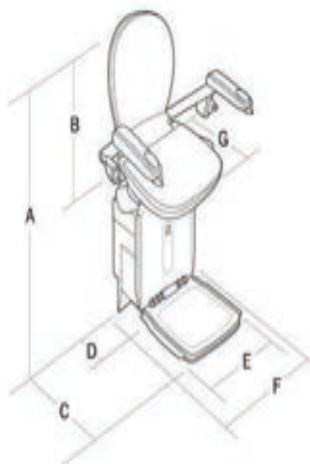

Dimensions	mm	inches
A Overall height	950-1100	43.5-500
B Height of seat	450	17.8
C Overall depth (from wall)	670	26.5
D Overall depth (when folded) E	360	14.2
Width of footrest	375	14.8
F Overall width	610	24
G Depth of seat	400	15.8
Weight limit 120kg/19st		



# Your questions answered

Hopefully by reading through our brochure we have answered any questions you may have, however we have answered some frequently asked questions below.

## **How long will I have to wait for my curved stairlift?**

Once you have placed an order with Leodis Stairlifts your stairlift can often be installed within days, and in some cases, as quickly as the very NEXT day.

## **How long will it take to install my curved stairlift?**

Our experienced, friendly engineer will fit your curved stairlift in approximately 3-4 hours, leaving your home as clean and tidy as it was found. He will demonstrate how to use your stairlift, answer any queries you may have and only when entirely satisfied do you pay.

## **Will my stairlift be attached to the wall?**

Many people think that stairlifts are fixed to the wall however this is not the case. Your stairlift will be attached directly to the staircase itself. During your free home survey our Leodis engineer will advise you on the most convenient side of the stairs for your stairlift and if anything i.e. if a radiator may need to be moved.

## **What happens if there is a power cut?**

Your stairlift will still work for a limited time if you have a power cut. The Bison 180 curved stairlift is battery operated and these re-charge when your stairlift is left on a charge point top or bottom of the track. Your curved stairlift will alert you by bleeping when it is not left on a charge point. If your stairlift batteries go flat they may need to be replaced.

## **Do you only sell new curved stairlifts?**

We offer both new and reconditioned curved stairlifts, available for NEXT day delivery in most cases. We can also install our curved stairlifts on a rental basis.

## **What do I do when I need a new carpet?**

The best time to replace your carpet is before installation however if this is not possible we can remove then reinstall your stairlift, a cost will be incurred for this service.

If you have any further questions or queries we will be happy to answer them in person.

**Call us NOW on 0800 542 6045**





# LEODIS STAIRLIFTS

HELPING YOU WITH THE UPS AND DOWNS IN LIFE

Est. 1991

At **LEODIS STAIRLIFTS** we know that finding the solution for you and your home is the most crucial part of the service so we use our wealth of knowledge and experience to find the product that best suits YOUR specific needs.

Call us now on

**0800 542 6045**

## CONTACT US

Email: [sales@leodisstairlifts.co.uk](mailto:sales@leodisstairlifts.co.uk)

[www.leodisstairlifts.co.uk](http://www.leodisstairlifts.co.uk)

